

VALVOLE IN GHISA

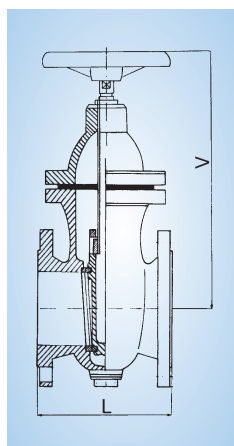

DENOMINAZIONE	MATERIALI
CORPO	GHISA G.JL
COPERCHIO	GHISA G.JL
CUNEO	GHISA G.JL
ALBERO	ACCIAIO INOX
MADREVITE	OTTONE
O-RING	NBR
ANELLO DI TENUTA	OTTONE
GUARNIZIONI	NBR
VOLANTINO	GHISA G.JL

SARACINESCA A CORPO PIATTO CON O-RING PN 10 <small>ESENTE DA MANUTENZIONE</small>					
CODICE	DN	L	V	PESO KG	EURO
4012	40	140	245	12	
4013	50	150	260	15	
4014	65	170	295	20	
4015	80	180	325	25	
4016	100	190	360	32	
4017	125	200	420	41	
4018	150	210	455	57	
4019	200	230	545	85	
4005	250	250	695	119	
4006	300	270	783	154	
4007	350	290	874	203	
4008	400	310	950	245	
4009	500	350	1150	418	
4010	600	390	1317	605	

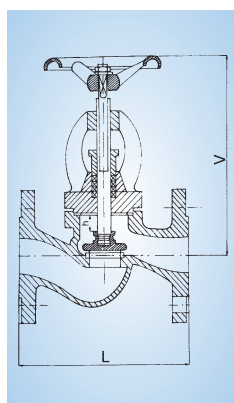

DENOMINAZIONE	MATERIALI
CORPO	GHISA G.JL
COPERCHIO	GHISA G.JL
PREMISTOPPA	GHISA G.JL
ALBERO E DISCO	ACCIAIO INOX
TENUTA SUL CORPO	ACCIAIO INOX
TENUTA SULL'ALBERO	GRAFITE
GUARNIZIONI	GRAFITE CON INSERTI Cr Ni St

VALVOLA A FLUSSO AVVIATO PN 16					
CODICE	DN	L	V	PESO KG	EURO
4050	15	130	188	3	
4051	20	150	188	4	
4052	25	160	196	5	
4053	32	180	207	7	
4054	40	200	254	9	
4055	50	230	266	12	
4056	65	290	300	17	
4057	80	310	336	23	
4058	100	350	377	32	
4059	125	400	430	46	
4060	150	480	474	63	
4061	200	600	607	114	
6320	250	730	754	210	

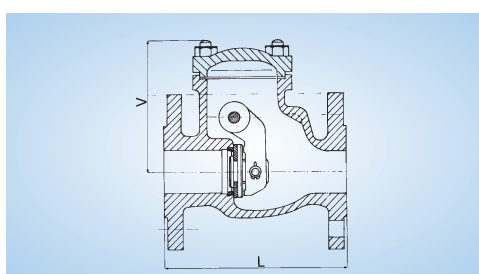

VALVOLA DI RITEGNO A CLAPET PN 16					
CODICE	DN	L	V	PESO KG	EURO
4029	40	180	119	7	
4030	50	200	120	10	
4031	65	240	141	15	
4032	80	260	168	18	
4033	100	300	175	29	
4034	125	350	199	43	
4035	150	400	217	62	
4036	200	500	277	146	
4037	250	600	337	245	
6311	300	700	360	250	

DENOMINAZIONE	MATERIALI
CORPO	GHISA G.JL
COPERCHIO	GHISA G.JL
BRACCIO	GHISA G.JL
DISCO	ACCIAIO INOX
PERNO E DADO DEL DISCO	ACCIAIO INOX
ANELLO DI TENUTA	ACCIAIO INOX
GUARNIZIONI	GRAFITE CON INSERTI Cr Ni St

VALVOLA DI RITEGNO A CLAPET PN 10					
CODICE	DN	L	V	PESO KG	EURO
4023	80	260	168	18	
4027	200	500	277	146	
4028	250	600	337	245	
6310	300	700	360	260	

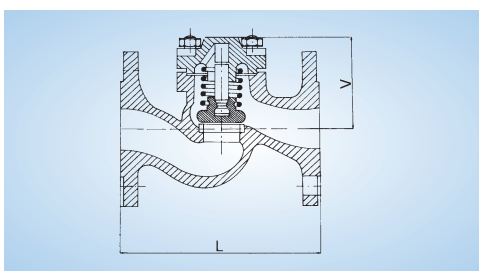

VALVOLA DI RITEGNO PN 16					
CODICE	DN	L	V	PESO KG	EURO
4038	15	130	53	2	
4039	20	150	53	3	
4040	25	160	59	4	
4041	32	180	63	6	
4042	40	200	95	8	
4043	50	230	95	10	
4044	65	290	110	14	
4045	80	310	130	18	
4046	100	350	158	26	
4047	125	400	184	39	
4048	150	480	204	58	
4049	200	600	257	110	

DENOMINAZIONE	MATERIALI
CORPO	GHISA G.JL
COPERCHIO	GHISA G.JL
ALBERO, OTTURATORE, MOLLA	ACCIAIO INOX
ANELLO DI TENUTA	ACCIAIO INOX
GUARNIZIONI	GRAFITE CON INSERTI Cr Ni St

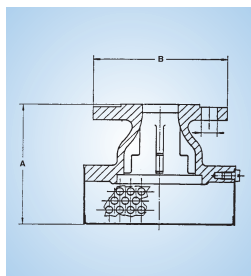

DENOMINAZIONE	MATERIALI
CORPO	GHISA G.J.L
COPERCHIO	GHISA G.J.L
SUCCHERUOLA	ACCIAIO INOX

FILTRO DI PRESA PN 10 CON SUCCHERUOLA					
CODICE	DN	A	B	PESO KG	EURO
6340	40	137	150	5	
6341	50	157	165	6	
6342	65	172	185	8	
6343	80	186	200	11	
6344	100	245	220	15	
6345	125	263	250	21	
6346	150	343	285	29	

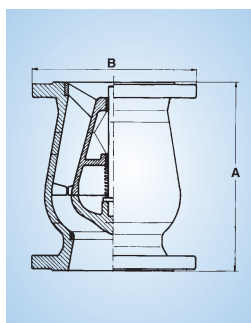

DENOMINAZIONE	MATERIALI
CORPO	GHISA G.J.L
OGIVA	OTTONE/GHISA G.J.S
OTTURATORE	INOX/GHISA G.J.S
SEGGIO CORPO	ACCIAIO INOX
STELO	ACCIAIO INOX
MOLLA	ACCIAIO INOX

IDROSTOP IN GHISA PN 16					
CODICE	DN	A	B	PESO KG	EURO
6250	50	120	165	7	
6251	65	150	185	11	
6252	80	180	200	17	
6253	100	240	220	23	
6254	125	300	250	33	
6255	150	350	285	45	
6256	200	400	340	75	
6257	250	450	405	115	
6258	300	500	460	145	

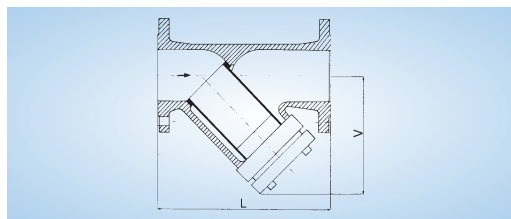

DENOMINAZIONE	MATERIALI
CORPO	GHISA G.J.L
COPERCHIO	GHISA G.J.L
CARTUCCIA FILTRANTE	ACCIAIO INOX
TAPPO DI SPURGO	OTTONE
GUARNIZIONI	GRAFITE CON INSERTI Cr Ni St

FILTRI A Y PN 16					
CODICE	DN	L	V	PESO KG	EURO
4062	15	130	70	2	
4063	20	150	70	3	
4064	25	160	86	4	
4065	32	180	102	6	
4066	40	200	108	7	
4067	50	230	118	8	
4068	65	290	141	13	
4069	80	310	160	17	
4070	100	350	190	25	
4071	125	400	223	35	
4072	150	480	295	56	
4073	200	600	368	95	
6400	250	730	450	165	
6401	300	850	680	285	

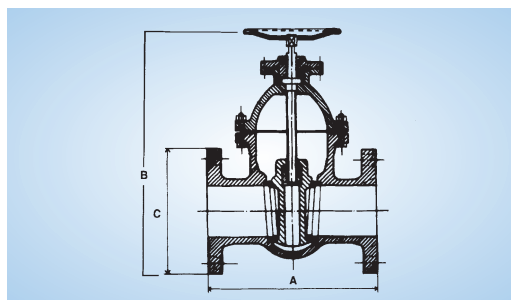

DENOMINAZIONE	MATERIALI
CORPO	GHISA G.J.L
CAPPELLO	GHISA G.J.L
CUNEO	GHISA G.J.S
FLANGETTA	GHISA G.J.S
ASTA, ANELLO DI TENUTA E DADO	OTTONE
TENUTA O-RING	GOMMA
VOLANTINO	ACCIAIO

SARACINESCA * A CORPO CILINDRICO PN 25						
CODICE	DN	A	B	C	PESO KG	EURO
6099	40	250	350	150	22	
6100	50	250	350	165	22	
6101	65	290	390	185	34	
6102	80	310	440	200	46	
6103	100	350	500	235	60	
6104	125	400	570	270	85	
6105	150	450	650	300	120	
6106	200	550	800	360	207	

SARACINESCA * A CORPO CILINDRICO PN 40						
CODICE	DN	A	B	C	PESO KG	EURO
6049	40	250	350	150	22	
6050	50	250	350	165	22	
6051	65	290	390	185	34	
6052	80	310	440	200	46	
6053	100	350	500	235	60	
6054	125	400	570	270	85	
6055	150	450	650	300	120	
6056	200	550	800	375	207	

* PER I DN 250-300-350 PREZZI A RICHIESTA